

Product Specification

04/2019

Product	LCD Display
Mode	APT12LCD760S-U -J 4-button
Abbreviation	760S-U

Client

Customer

audit

Supplier	APT(Tianjin) Develop Co.,Ltd..
-----------------	--------------------------------

1001, Building 5 HuaDing, No.1 HuaKe 3 Road, Binhai hi-tech Industrial Development Zone, Tianjin, China

Tel	TEL:+86 22 83715556 FAX:+86 22 83719955
------------	--

Email	<u>yzhao@aptdevelop.com</u>
--------------	---

1. Product Name

- ✧ LCD display
- ✧ Model : APT12LCD 760S-U

2. Suppliers

- ✧ APT(Tianjin) Develop Co.,Ltd.
- ✧ Email : yzhao@aptdevelop.com apt@aptdevelop.com

3. Electrical Parameters

- ✧ LCD screen
- ✧ 24V/36V/48V battery supply
- ✧ Rated operating current : 10mA
- ✧ Off leakage current < 1uA
- ✧ Max output current to controller : 50mA
- ✧ USB type A, 5V/500mA, Support android and iPhone phones with short circuit protection and overcurrent protection
- ✧ Operating temperature : -30~70°C, Storage temperature : -40~70°C

4. Dimensions & Material

- ✧ Product shell is ABS, transparent window is made with high strength Acrylic.
- ✧ Dimensions : host/L94mm*W65mm*H69.81mm



5. Features

- ◇ Suitable for low temperature, Max -30℃..
- ◇ Ergonomic external button design, easy to operate.
- ◇ **Speed display:** AVG SPEED, MAX SPEED, SPEED (Real-time).
- ◇ **Kilometer / Mile:** Can be set according to customers' habits.
- ◇ **Smart battery indicator:** Provide a reliable battery indicator.
- ◇ **9-level Assist :** 3-level/5-level/9-level optional.
- ◇ **Mileage indicator:** Odometer/Trip distance/ Clock/ Riding time.
- ◇ **USB changing port :** 5V 500mA
- ◇ **Error code indicator.**
- ◇ **Software upgraded:** Software can be upgraded through UART.

6. LCD screen instructions

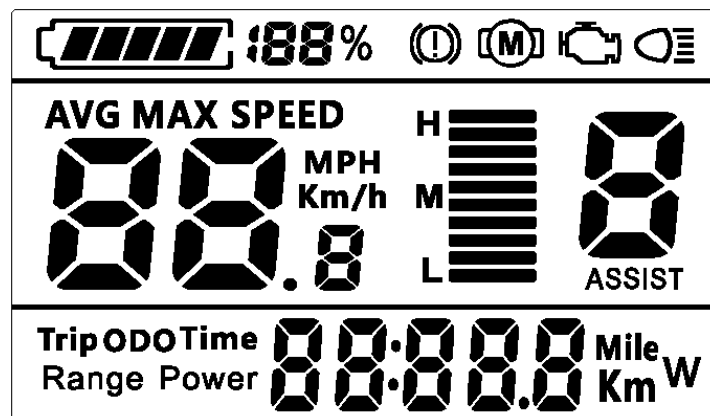

7. Functional Description

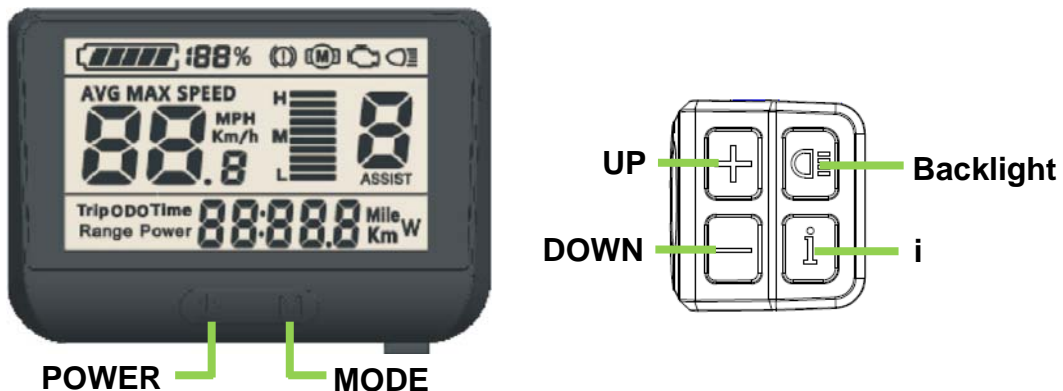

7.1 Power On/Off

Press and hold **POWER** button for 1 second can turn on/off the display. The Display can automatically shut down when there is no operate & ride for X minutes (X could be 0~15) .

7.2 Assist level operating

Short press **UP/DOWN** button can change the assist level. Top assist level is 5, 0 for neutral. Level quantities can be adjusted according to the customer requirements.

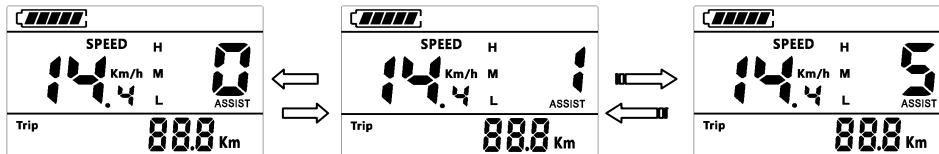

7.3 Speed mode switch& Mileage mode switch

Short press **i** or **MODE** button can change the speed mode, **AVG Speed->MAX Speed->Speed->ODO->Time->Trip**.

7.4 Headlight/backlight On/Off

Press and hold **☰** button for 1 second can turn on/off the headlight/backlight, if press **☰** button for 1 second again, then display backlight/headlight will turn off.

*The motor does not work when the battery voltage is low, Display still can keep the headlight on for a while when E-bike is in riding.

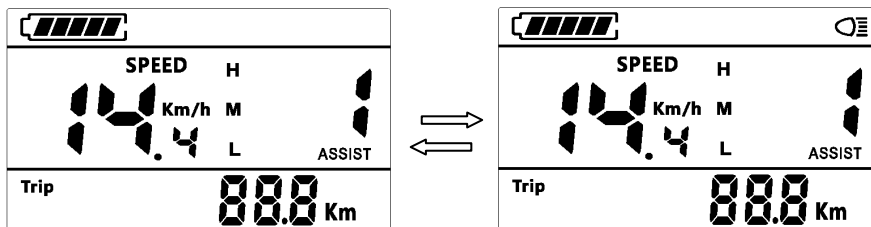

7.5 Walking mode (6km)

Press and hold **DOWN** button for 2 second can get into walking mode, out of the mode when release the button.

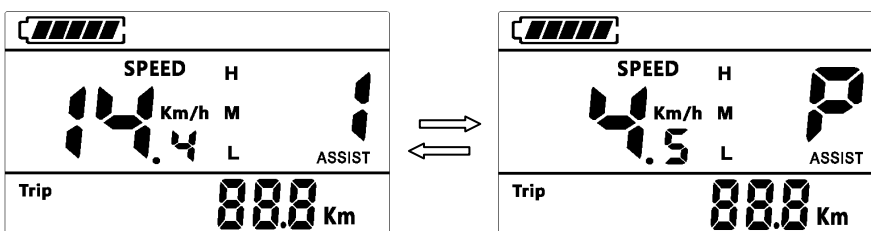

* This feature needs to be supported by controller.

7.6 Battery Capacity Indication

5 bars in display to show battery capacity, if battery under voltage, then no bar in display, then battery needs to be charged immediately

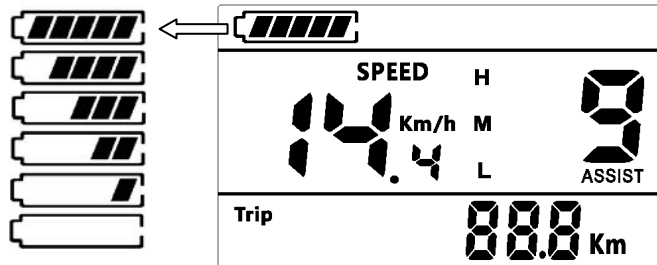

Battery voltage: 36V

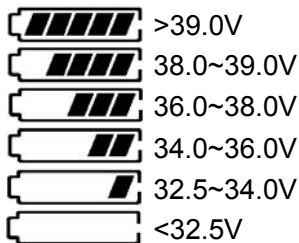

Battery voltage: 48V

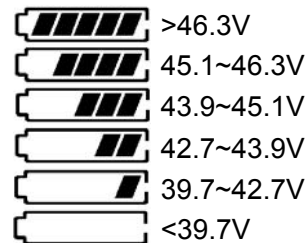

7.7 Data cleanup

In parameter setting state, can reset several temporary data, temporary data include **AVG Speed / MAX Speed / Trip / Time**.

* These temporary data can't be erased by power off.

8. Parameter setting

Double press **MODE** button (press interval less than 0.3 second) can get into parameter setting state, under this, parameter could be set. And double press **MODE** button (press interval <0.3 second) to exit. In parameter setting state, when flashing, press **UP/DOWN** buttons to adjust parameters, short press **MODE** button to switch parameter items

*The display will automatically exit parameters setting state if no operation for 10 seconds.

The order of parameters are as follow.

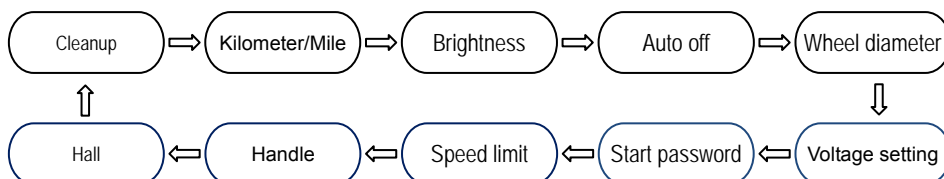

8.1 Cleanup (Cr): Press **UP/DOWN** button to switch between n (No) /y (Yes).

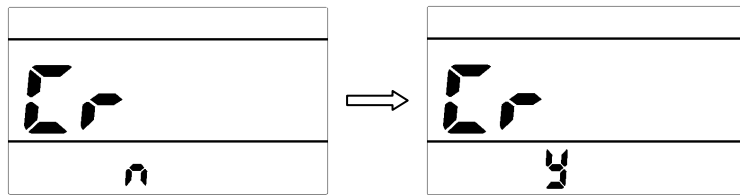

8.2 Kilometer / Mile (S7): Press **UP/DOWN** button to change between **km/h / MPH** (Km / Mile).

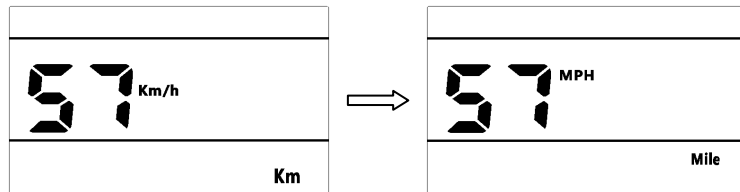

8.3 Brightness(bL1) : Press **UP/DOWN** button to change the brightness of the backlight, **1** is darkness, **5** is brightness

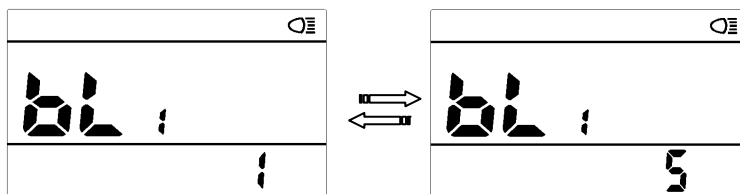

8.4 Auto off (OFF): Press **UP/DOWN** button to change the auto power off time, from 0 to 15, the number represent time (minutes) to shutdown, default value is 5 minutes.

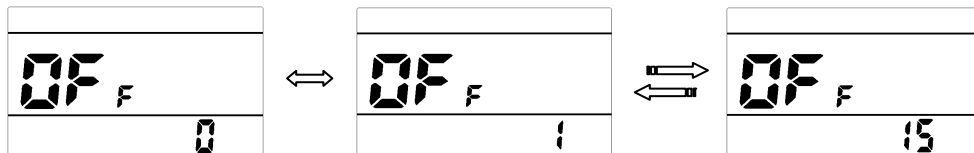

8.5 Wheel diameter (dH): Press **UP/DOWN** button to change between [16/18/20/22/24/26/27/28/700C/29](#), value represents the diameter of the wheel (inch). Wrong value for wheel diameter will cause speed & mileage abnormal.

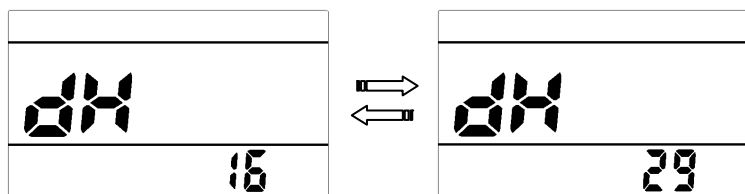

8.6 Voltage Setting (bU0): Press **UP/DOWN** button to switch between **24V/36V/48V/UbE, UbE** means user-defined voltage setting, this parameter can be set through computer.

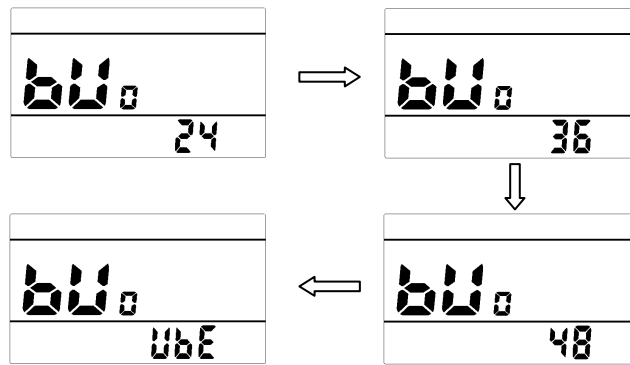

8.7 Start Password (PSd): Press **UP/DOWN** button to change the password value (0~9), short press **MODE** button to switch the password item, password is 4 digits, the default password is "1919". Press **MODE** button when password adjustment is completed. Display will return to the **Voltage set** item if the password is incorrect. Correct password will enter the **Speed Limit Setting** item.

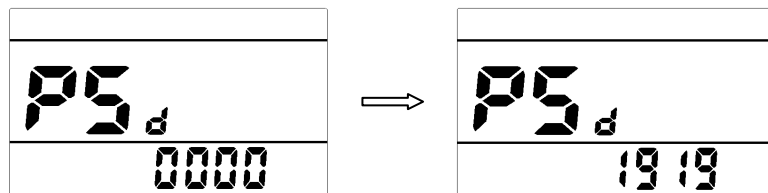

8.8 Speed limit (SPL): Press **UP/DOWN** will change speed limit, range 10km/h~41km/h. Default value is 25km/h.

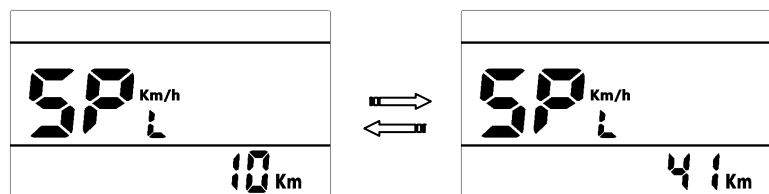

* The maximum speed is restricted by the motor and controller, probably couldn't reach the setting value.

8.9 Handle (Hd): Press **UP/DOWN** will change 0(OFF)/1(ON).

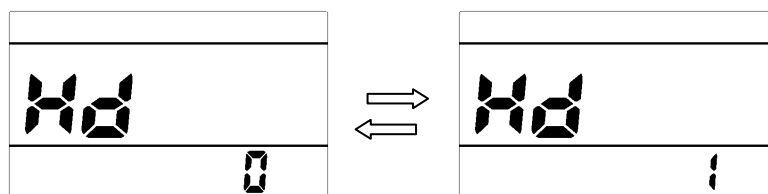

8.10 Hall (HAL): Press **UP/DOWN** will change Hall value, range 1~15.

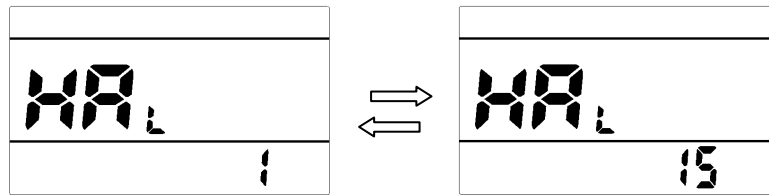

9. Error Code define

760S can show warning message,  icon shows on the screen, and show error code at the bottom of the screen, error code from 21H~30H, definition see the table below.

Error Code	Error description	Handle
21H	Current abnormal	
22H	Turn error	Check turn to connect.
23H	Motor phase lost	
24H	Hall error	Check the hall connection
25H	Brake error	Check the brake connection.
30H	Communication Error	

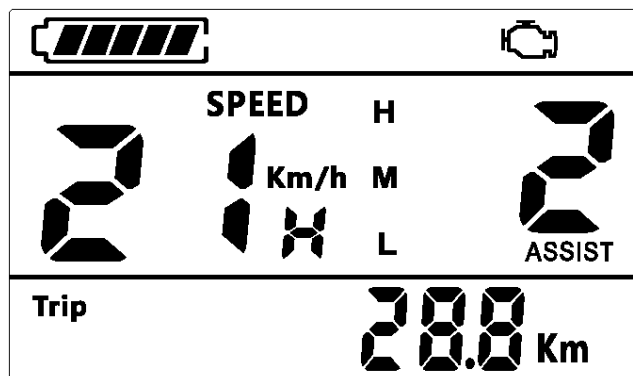

10. Assembly instructions

Please pay attention to the screw's torque value, damaged caused by excessive torque is not within the scope of the warranty.

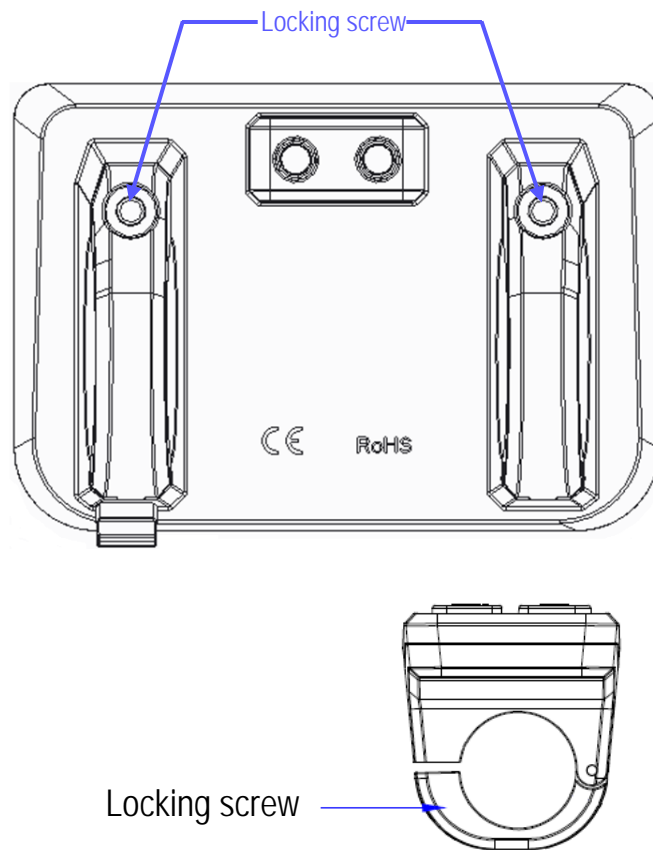

Clamps suit for 3 size of handlebar, 31.8mm, 25.4mm, 22.2mm, there are transfer rings for 25.4mm and 22.2mm, transfer ring must be assembled with the special directions, pay attention to the green arrow below.

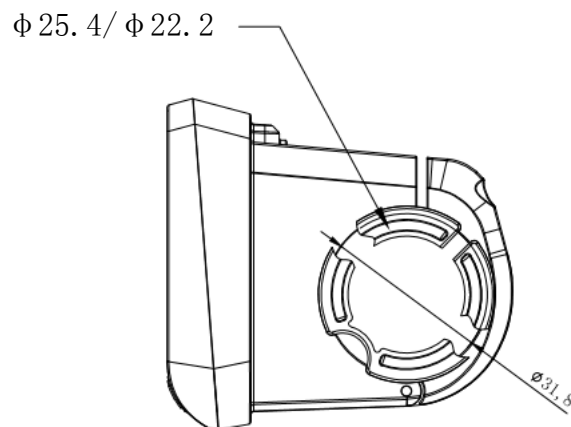

11. Connector descriptions

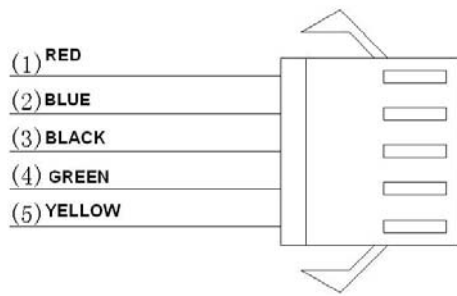

- 1、 Red wire : Anode(24v/36v/48V)
- 2、 Blue wire : Power cord to the controller
- 3、 Black wire : GND
- 4、 Green wire : RxD (controller -> display)
- 5、 Yellow wire : TxD (display -> controller)

12. Assist level instructions

Assist level can be customized, the highest level is 9, and common used assist level see the table below:

3 level	5 level	9 level	
0		0	No power assist
	1	1	
		2	
1	2	3	
		4	
	3	5	
2		6	
	4	7	
		8	
3	5	9	

13. Certification

CE / IP65 (water proof) / ROHS.